

Eivissa Collection

ETHIMO

OUTDOOR DECOR



Eivissa Collection

ETHIMO

OUTDOOR DECOR



Index

- 034 Eivissa Collection
- 006 Climate
- 016 Light & Proof
- 024 Open air
- 034 I materiali /
The materials /
Les matériaux
- 042 Info tecniche / Technical
info / Infos techniques
- 044 Padiglione con frame di
base e pavimenti /
Pavillion with base frame
and flooring / Pavillon avec
base et plancher
- 048 Padiglione senza frame di
base / Pavillion without
base frame / Pavillon sans
base
- 050 Elementi di completamento /
Complemetary elements /
Elements complémentaires
- 052 Tenda scorrevole Flow /
Flow sliding curtain /
Rideau coulissant Flow
- 053 Pannelli vetrati / Glazed
panels / Panneaux vitrés
- 054 Tende perimetrali in
tessuto / Side fabric
curtains / Rideaux
latéraux en tissus
- 055 Tende perimetrali in corda
intrecciata / Side woven
rope curtains / Rideaux
latéraux en corde tressée
- 056 Attacchi elettrici /
Electrical unit /
Raccordements électriques
- 059 Lis tino / Price list /
Liste de prix

Eivissa collection

design Ludovica + Roberto Palomba.

it / I padiglioni Eivissa sono moduli abitativi progettati per creare ambienti protetti dal sole, dal vento o dalla pioggia, che si inseriscono nel paesaggio naturale come architetture contemporanee e funzionali. Vere e proprie stanze a cielo aperto in cui apprezzare l'esterno in pieno comfort. Con una solida struttura in alluminio, ogni padiglione diventa unico grazie alla scelta dei colori, delle coperture, dei pavimenti e degli accessori che lo vestono e lo decorano.

en / Eivissa pavilions are living modules designed to create spaces that provide shelter from the sun, wind and rain, contemporary functional pieces of architecture that fit into natural settings. Real open-air rooms in which to enjoy outdoor living in total comfort. With a robust structure in aluminium, each pavilion can be made exclusive thanks to a wide choice of colours, roofs, floors and perimeter and decorative accessories.

fr / Modules d'habitat conçus pour créer des espaces protégés du soleil, du vent et de la pluie, les pavillons Eivissa s'intègrent dans le contexte paysager comme des ouvrages architecturaux à la fois contemporains et fonctionnels. De véritables pièces à ciel ouvert, idéales pour apprécier le plein air sans renoncer à aucun confort. Doté d'une structure en aluminium solide, chaque pavillon devient exclusif de par le choix des couleurs, des revêtements, des planchers et des accessoires qui l'habillent et le décoorent.





Eivissa

Climate

it / Eivissa Climate è una struttura bioclimatica con copertura a lamelle orientabili motorizzate. Questa soluzione risponde in modo sofisticato e funzionale ad esigenze modulabili di luce, ombra, impermeabilità e ventilazione creando al suo interno un clima e un'ombreggiatura ideali e offrendo una buona protezione dalle intemperie.

en / Eivissa Climate is a bioclimatic structure with roof in adjustable motorised louvers. This solution is a sophisticated, practical answer to variable requirements for light, shade, waterproofness and ventilation, creating the ideal climate and shade inside and offering good protection against the elements.

fr / Eivissa Climate est une structure bioclimatique dotée d'une couverture à lames orientables motorisées. Cette solution répond de manière sophistiquée et fonctionnelle aux besoins modulaires de lumière, d'ombre, d'imperméabilité et de ventilation, car elle est en mesure de créer un climat et un ombrage idéaux, et d'offrir une bonne protection contre les intempéries.

Eivissa
Climate







Copertura Climate / Climate covering / Couverture Climate.

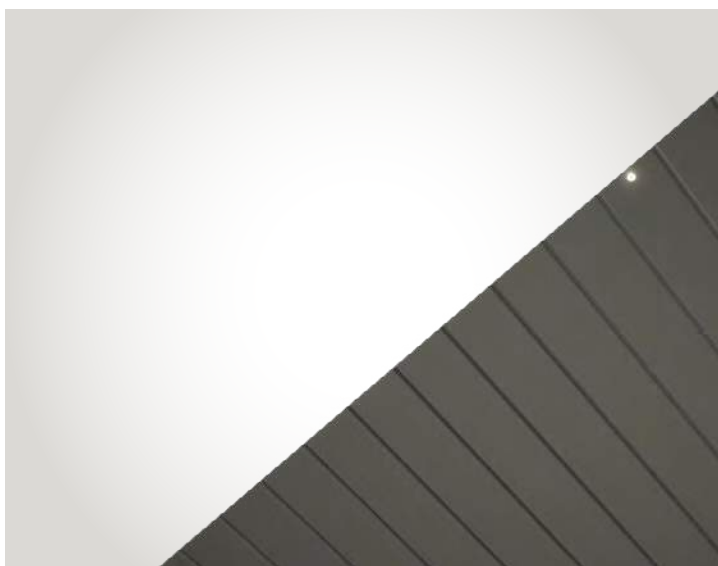

Copertura Climate con illuminazione / Climate covering with lighting
/ Couverture Climate avec éclairage.

Eivissa Climate

it / Il padiglione Eivissa con copertura bioclimatica è dotato di un tetto con lamelle di alluminio che possono essere orientate elettricamente da 0° a 90°. Le lame non completamente aperte consentono un piacevole passaggio dell'aria e schermano la luce diretta del sole, mentre la loro completa chiusura ripara perfettamente l'ambiente sottostante dalla luce e dalla pioggia, che defluisce nei pluviali integrati. Eivissa Climate può diventare uno spazio unico e riservato grazie anche alla possibilità di applicare su tutti i lati vetrate scorrevoli e tende.

en / The Eivissa pavilion with bioclimatic roof is fitted with aluminium louvers that can be electrically adjusted from 0° to 90°. Left slightly open, these louvers provide pleasant ventilation and shield against direct sunlight. When completely closed, they shelter the underlying space against the light and the rain, which runs off into the built-in drainpipes. Eivissa Climate can be turned into a unique, private space thanks also to the option of adding sliding glass panels and curtains on all the sides.

fr / Le pavillon Eivissa à couverture bioclimatique est doté d'une toiture à lames en aluminium qui peuvent être orientées électriquement de 0° à 90°. Quand elles ne sont pas complètement ouvertes, les lames permettent une agréable circulation d'air tout en protégeant de l'ensoleillement direct, en revanche, lorsqu'elles sont totalement fermées, elles abritent parfaitement le milieu environnant de la lumière et de la pluie, évacuée via des gouttières intégrées. Eivissa Climate peut devenir un espace unique et intime grâce aussi à la possibilité d'appliquer, sur tous les côtés, des panneaux vitrés coulissants et des rideaux.

Ethimo / Outdoor decor

The italian style for outdoor living

Eivissa Climate





it / Eivissa Climate
495 x 375 cm con
pavimento in teak, chiusura
laterale con vetrate scorrevoli
e tende in tessuto.
Arredi della collezione
Knit – design Patrick Norguet.

en / Eivissa Climate
495 x 375 cm with
teak decking, and closed sides
in sliding glass panels and
fabric curtains. Furnishings
from the Knit collection,
designed by Patrick Norguet.

fr / Eivissa Climate
495 x 375 cm avec
plancher en teck, fermeture
latérale avec panneaux vitrés
coulissants et rideaux en tissu.
Mobilier de la collection
Knit – dessiné par Patrick
Norguet.

Eivissa Climate

it / Eivissa Climate
495 x 495 cm senza
pavimento, tenda superiore
scorrevole Flow, pannelli
laterali in corda intrecciata.
Arredi della collezione Swing
– design Patrick Norguet.

en / Eivissa Climate
495 x 495 cm without
floor, Flow sliding roof canopy,
side panels in woven rope.
Furnishings from the Swing
collection, designed by Patrick
Norguet.

fr / Eivissa Climate
495 x 495 cm sans
plancher, rideau supérieur
coulissant Flow, panneaux
latéraux en corde tressée.
Mobilier de la collection
Swing – dessiné par Patrick
Norguet.





Eivissa Light & Proof







Eivissa

Light & Proof

it / Eivissa Light & Proof crea una stanza a cielo aperto, protetta dalla pioggia e dalle intemperie, all'insegna della funzionalità e dello stile. Un ambiente affascinante, uno spazio protetto ed accogliente, per vivere in continuità con la natura.

en / Eivissa Light & Proof creates an open-air room, sheltered against the rain and inclement weather, that is both practical and stylish. A very attractive, sheltered, welcoming space in which to enjoy outdoor living.

fr / Eivissa Light & Proof crée une pièce en plein air, protégée de la pluie et des intempéries, alliant fonctionnalité et style. Une ambiance fascinante, un espace protégé et accueillant, pour vivre en continuité avec la nature.

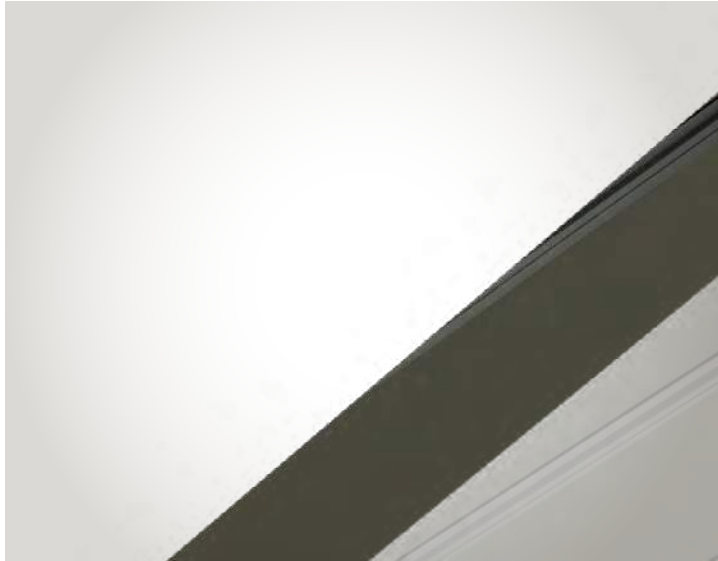

Copertura Light & Proof con policarbonato Fumè / Light & Proof covering with Fumè polycarbonate / Couverture Light & Proof avec Fumè polycarbonate.



Copertura Light & Proof con policarbonato View e tenda scorrevole Flow / Light & Proof covering with View polycarbonate and Flow sliding canopy / Couverture Light & Proof avec View polycarbonate et rideau coulissant Flow.

Eivissa

Light & Proof

it / Il padiglione Eivissa Light & Proof è dotato di una copertura fissa in policarbonato compatto che garantisce una perfetta impermeabilità. Sotto la copertura, disponibile nelle due varianti Light e Fumé, è possibile montare una tenda scorrevole in tessuto ombreggiante per schermare l'ambiente dal sole. Tutto il perimetro può essere completato con vetrate scorrevoli o morbide tende.

en / The Eivissa Light & Proof pavilion has a fixed roof in compact polycarbonate that guarantees perfect waterproofness. A sliding fabric canopy, in one of two variants Light and Fumé, can be added under the roof, to provide shade from the sun. The whole perimeter can be completed with sliding glass panels or soft curtains.

fr / Le pavillon Eivissa Light & Proof est doté d'une couverture fixe en polycarbonate compact garantissant une imperméabilité parfaite. Il est possible de monter sous celle-ci (disponible en deux versions : Light et Fumé) un rideau coulissant en tissu d'ombrage pour protéger le pavillon du soleil. L'ensemble du périmètre peut être complété par des panneaux vitrés coulissants ou des rideaux souples.

Eivissa Light & Proof

it / Eivissa Light & Proof
375 x 375 cm con
tenda superiore scorrevole
Flow, pavimento in pietra
ceramica, chiusura laterale con
vetrate scorrevoli e tende in
tessuto. Arredi della collezione
Swing – design Patrick
Norguet.

en / Eivissa Light & Proof
375 x 375 cm with
Flow sliding roof canopy,
ceramic stone flooring, and
closed sides in sliding glass
panels and fabric curtains.
Furnishings from the
Swing collection, designed by
Patrick Norguet.

fr / Eivissa Light & Proof
375 x 375 cm avec
rideau supérieur coulissant
Flow, plancher en pierre
céramique, fermeture
latérale avec panneaux vitrés
coulissants et rideaux en tissu.
Mobilier de la collection Swing
– dessiné par Patrick Norguet.





Eivissa

Open Air

it / Eivissa Open Air è ideale per spazi in cui si desidera modulare l'apertura totale e l'ombra. Può avere il tetto completamente o parzialmente aperto e un'ombreggiatura regolabile grazie alla tenda scorrevole Flow.

en / Eivissa Open Air is ideal for spaces where either total sunlight or shade are required. The roof can be either completely or partially opened and adjustable shade is provided by Flow sliding canopy.

fr / Eivissa Open Air est idéal pour les espaces où l'on souhaite moduler l'ouverture totale et l'ombre. Le toit peut être entièrement ou partiellement ouvert, et le rideau coulissant Flow permet de régler l'ombrage.



Eivissa
Open Air

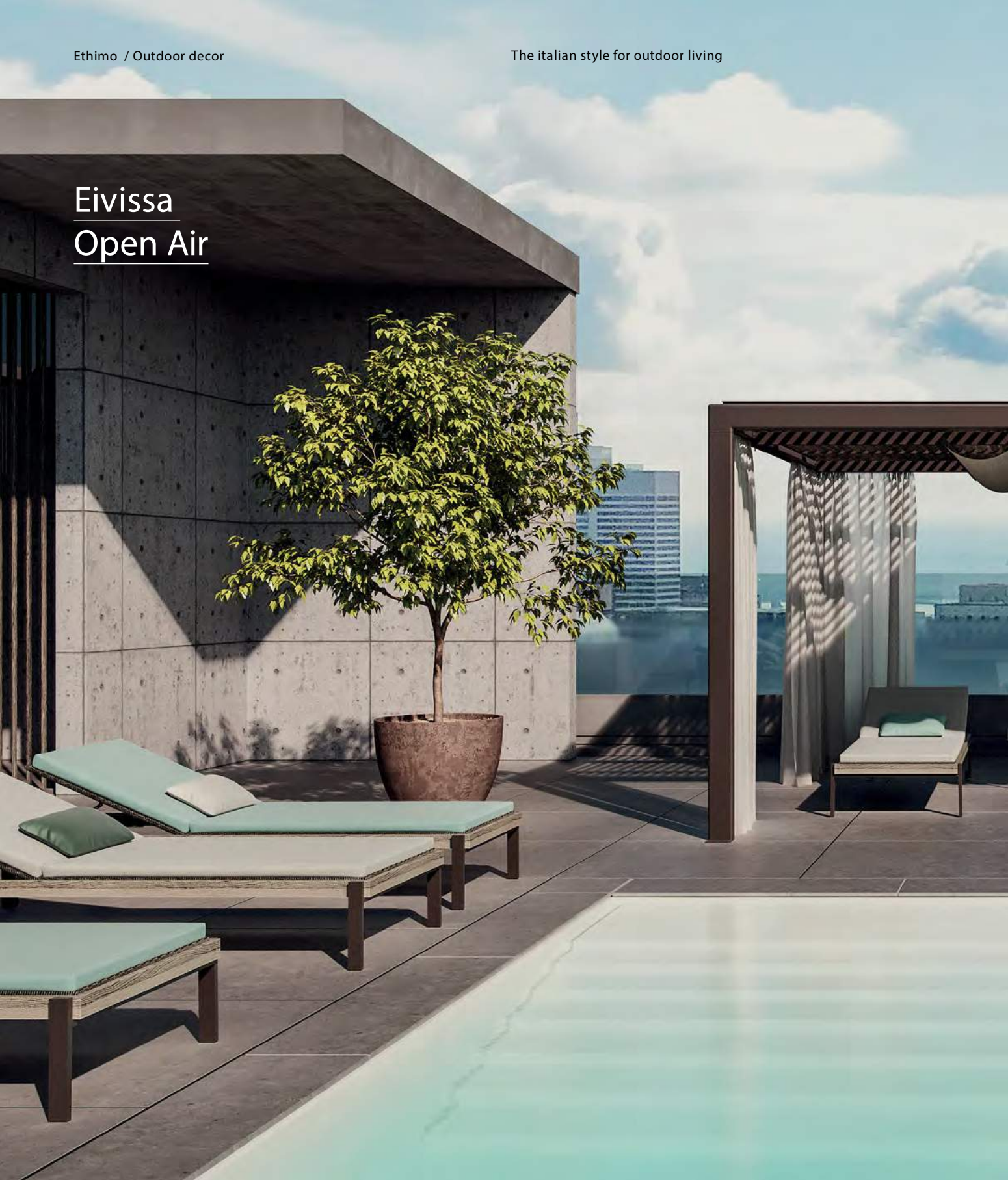



Eivissa Open Air

it / Eivissa Open Air
375 x 375 cm con
copertura a lamelle fisse di
teak, tenda scorrevole Flow e
tende laterali in tessuto.
Arredi della collezione
Allaperto – design Matteo
Thun & Antonio Rodriguez .

en / Eivissa Open Air
375 x 375 cm with
fixed teak louvers covering,
Flow sliding curtain and side
fabric curtains. Furnishings
from the Allaperto collection
– designed by Matteo Thun &
Antonio Rodriguez .

fr / Eivissa Open Air
375 x 375 cm
couverture avec lames fixes
en teak, rideau supérieur
coulissant Flow et rideaux
latéraux en tissu. Mobilier de la
collection Allaperto – dessiné
par Matteo Thun & Antonio
Rodriguez .





Copertura Open Air con tenda scorrevole Flow / Open Air covering with Flow sliding canopy / Couverture Open Air avec rideau coulissant Flow.

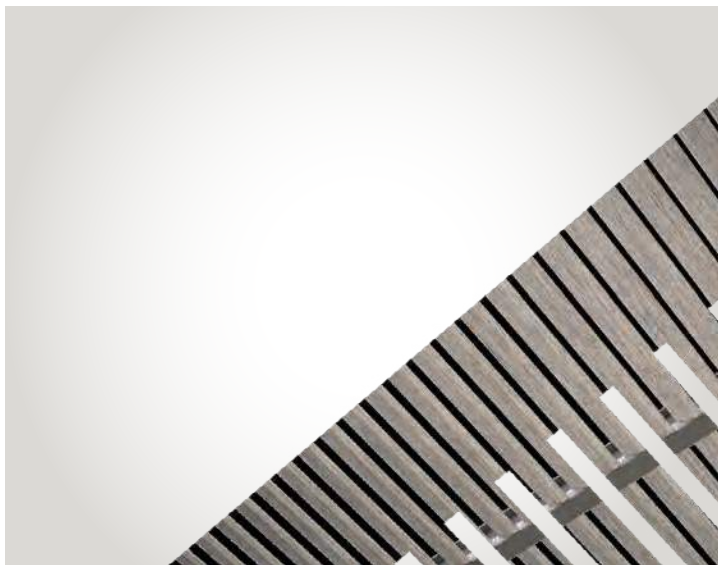

Copertura Open Air con lamelle fisse di teak decapato / Open Air covering with pickled teak fixed louvers / Couverture Open Air avec lames fixes en teck décapé.

Eivissa

Open Air

it / Il padiglione Eivissa Open Air è privo di coperture strutturali impermeabili. Il tetto superiore può essere lasciato totalmente libero oppure può prevedere una copertura in lamelle fisse di teak con finitura decapata. Sul soffitto interno può essere montata, in entrambi i casi, una tenda scorrevole in tessuto, per ombreggiare e creare un ambiente fresco e riparato. I lati possono essere completati con tende scorrevoli in tessuto o pannelli decorativi in corda intrecciata.

en / The Eivissa Open Air pavilion has no waterproof roof structure. The external roof can be left completely free or fitted with fixed teak louvers in a pickled finish. In both cases a sliding fabric canopy can be fitted to the roof lining, to provide shade and create a cool sheltered space. The sides can be completed with sliding curtains in fabric or decorative panels in woven rope.

fr / Le pavillon Eivissa Open Air ne présente pas de toiture imperméable. Le toit supérieur peut être laissé complètement libre, ou être recouvert de lames fixes en teck avec une finition décapée. Dans les deux cas, il est possible de monter au plafond un rideau coulissant en tissu afin d'ombrager l'espace et d'obtenir ainsi fraîcheur et protection. Les côtés peuvent être complétés par des rideaux coulissants en tissu ou des panneaux décoratifs en corde tressée.

Eivissa Open Air

it / Eivissa Open Air
375 x 375 cm con
tenda superiore scorrevole
Flow e tende laterali in tessuto.
Arredi della collezione
Grand Life – design
Christophe Pillet.

en / Eivissa Open Air
375 x 375 cm with
Flow sliding canopy and side
curtains in fabric. Furnishings
from the Grand Life collection,
designed by Christophe Pillet .

fr / Eivissa Open Air
375 x 375 cm avec
rideau supérieur coulissant
Flow et rideaux latéraux
en tissu. Mobilier de la
collection Grand Life – design
Christophe Pillet .





Ethimo / Outdoor decor

The italian style for outdoor living



Eivissa . Materiali e
informazioni tecniche.
Materials and technical info.
Matériaux et informations
techniques.

Riepilogo / Summary / Résumé

Lati / Sides / Côté

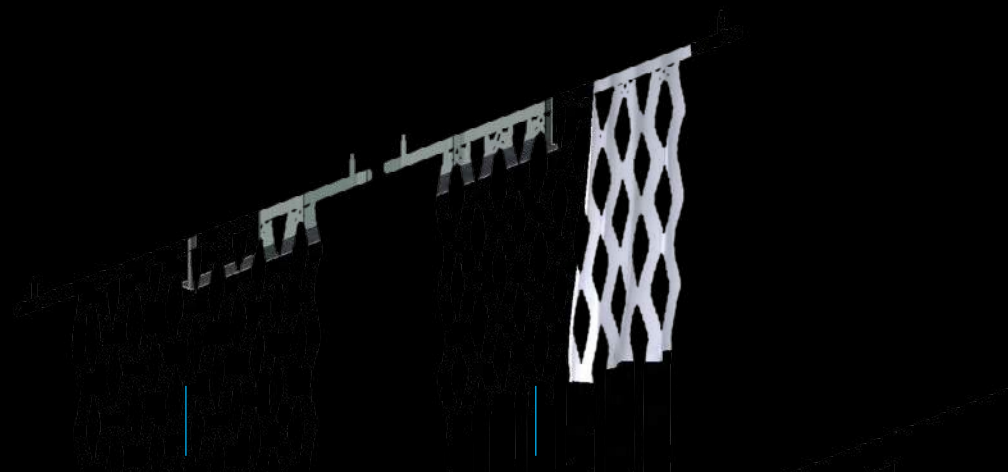

Tende perimetrali in corda
intrecciata / Perimeter
curtains in woven rope
/ Rideaux latéraux en corde
tressée

Pannelli vetrati / Glass panels
/ Panneaux vitrés

Tende perimetrali in tessuto
/ Perimeter curtains in fabric
/ Rideaux latéraux en tissus

Copertura/ Roof / Toit

Pavimento / Flooring / Plancher

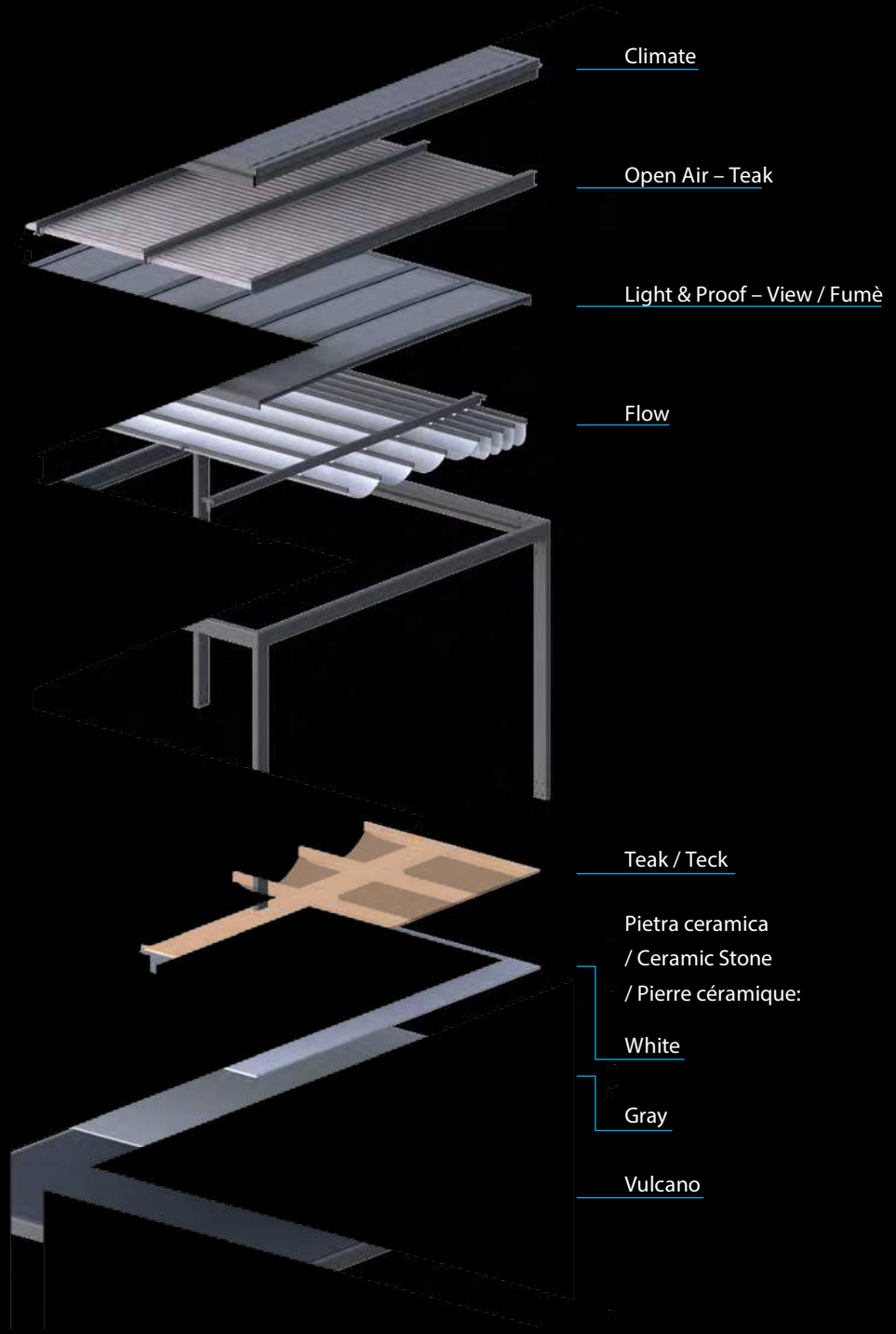

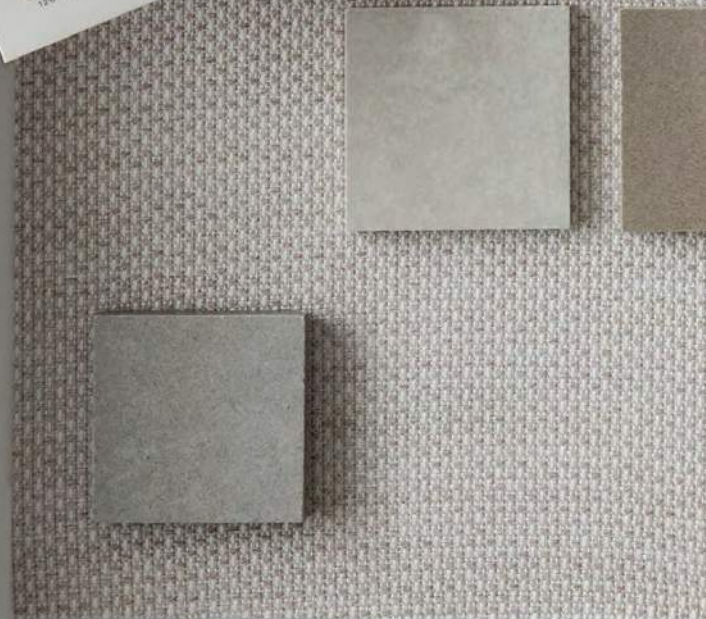



Ethimo / Outdoor decor

The italian style for outdoor living

it / Colori struttura
e componenti in
alluminio.

en / Frame and aluminium
components colours.

fr / Couleurs structure
et éléments en
aluminium.



43 / Aluminium
Textured matt
Warmwhite



44 / Aluminium
Textured matt
Warmgrey



G / Aluminium
Textured matt
Dark Grey



51 / Aluminium
Textured matt
Coffee Brown



R / Aluminium
Textured matt
Warmred

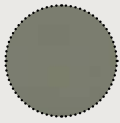

60 / Aluminium
Textured matt
Camouflage
Green



61 / Aluminium
Textured matt
Camouflage
Grey

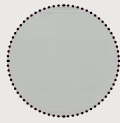

62 / Aluminium
Textured matt
Pearl
Grey



63 / Aluminium
Textured matt
Camouflage
Brown

it / Pavimenti.

en / Flooring.

fr / Sols.



T1 / Teak



LB / Ceramic
Stone White



LT / Ceramic
Stone Grey



LV / Ceramic
Stone Black
Vulcano

it / Polycarbonato.

en / Polycarbonate.

fr / Polycarbonate.



PC0 /
Polycarbonate
View



PC1 /
Polycarbonate
Fumè

it / Tenda scorrevole
Flow.

en / Flow sliding canopy.

fr / Rideau coulissant
Flow.

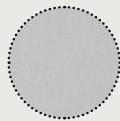

68 / Acrylic
Ecrú

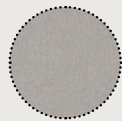

69 / Acrylic
Argilla



70 / Acrylic
Pietra



12 / Acrylic
Dove Grey



67 / Acrylic
Heirtage
Red

it / Lamelle fisse.

en / Fixed louvers.

fr / Lames fixes.



T5 / Pickled
Teak

it / Pareti vetrate.

en / Glass panels.

fr / Panneaux vitrés.

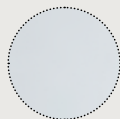

VE / Tempered
Crystal

Ethimo / Outdoor decor

The italian style for outdoor living

it / Tende perimetrali in tessuto.

en / Perimeter curtains in fabric.

fr / Rideaux latéraux en tissu.

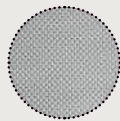

85 / Acrylic
Aluminium

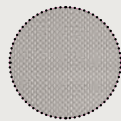

86 / Acrylic
Sand

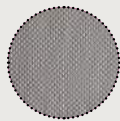

87 / Acrylic
Marmot

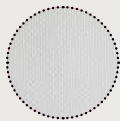

88 / Acrylic
Chalk

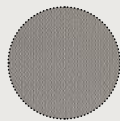

V75 / Velum
Grey Stone



V78 / Velum
White Stone

it / Tende perimetrali in corda intrecciata.

en / Perimeter curtains in woven rope.

fr / Rideaux latéraux en corde tressée.



R72 /
Polypropylene
Dove Grey



R73 /
Polypropylene
Light Grey

Eivissa . Dimensioni e pavimenti.
Dimensions and flooring.
Dimensions et planchers.

Padiglione con base e pavimento / Pavilion with base and flooring / Pavillon avec base et planchers

it / Ogni padiglione Eivissa può essere completo di base pavimentata, oppure installato direttamente a terra con opportune staffe di fissaggio. La base di alluminio, in cui è inclusa la pedana, è parte integrante del design del padiglione e permette di sollevarlo dal pavimento sottostante creando una cellula abitativa isolata e ben definita. La pedana può ospitare una pavimentazione a doghe di teak massello o in lastre di ceramica con effetto pietra di diversi colori. Nelle versioni con base possono essere applicate anche le guide per le vetrate scorrevoli.

en / Every Eivissa pavilion can be completed with a flooring base or installed directly on the ground using suitable fixing brackets. The aluminium base that supports the platform is built into the pavilion, raising it from the ground to create an insulated, well-defined living unit. The platform can be finished with solid teak decking or stone-effect ceramic tiles in a range of colours. The versions with a base can also be fitted with floor guides for the sliding glass panels.

fr / Tous les pavillons Eivissa peuvent être équipés d'une base et d'un plancher, ou être installés directement sur le sol avec des supports de fixation appropriés. La base en aluminium, qui comprend l'estrade, fait partie intégrante de la conception du pavillon et permet de le soulever du plancher sous-jacent, créant ainsi un espace de vie isolé et bien défini. L'estrade peut accueillir un plancher de lattes de teck massif ou de dalles de céramique effet pierre de différentes couleurs. Dans les versions avec base, il est également possible d'installer des rails de guidage pour les panneaux vitrés coulissants.

Materials

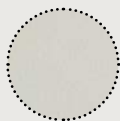

Aluminium
Warm White



Aluminium
Warm Grey



Aluminium
Warm Red



Aluminium
Dark Grey



Aluminium
Coffee
Brown

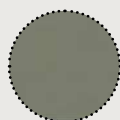

Aluminium
Camouflage
Green



Aluminium
Camouflage
Grey



Aluminium
Pearl
Grey



Aluminium
Camouflage
Brown

Dimensioni / Dimensions / Dimensions

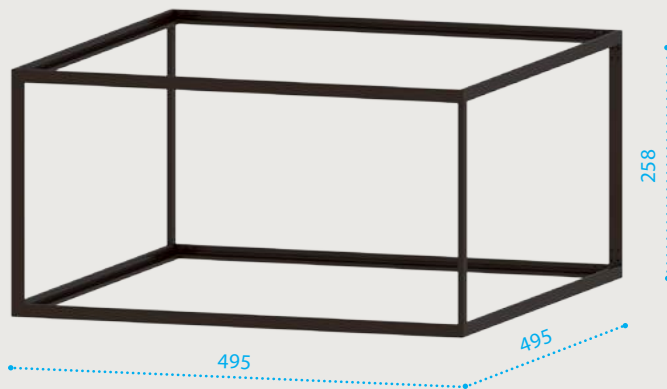
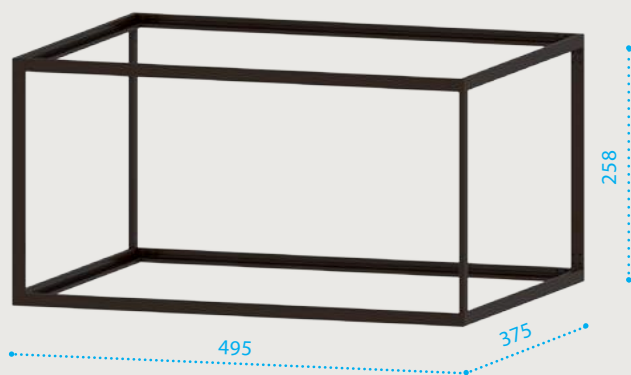
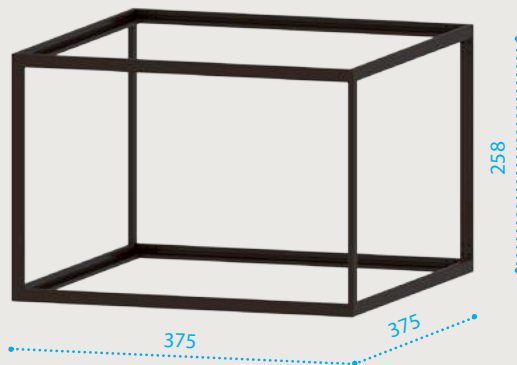

Pavimenti / Flooring / Planchers



it / Il pavimento in teak è composto da doghe di legno massello di spessore 19 mm, lunghe 120 cm e larghe 12 cm. Le doghe hanno superficie liscia e sono preventivamente trattate contro macchie e sporco. Il montaggio è semplice e veloce e viene effettuato su supporti regolabili in altezza per consentire il migliore adattamento al fondo sottostante.

en / The teak decking is made from solid wood slats, 19 mm thick, 120 cm long and 12 cm wide. The slats are smooth and already treated to resist stains and dirt. They are simple and quick to assemble on supports that can be adjusted in height to give perfect results on the underlying base.

fr / Le plancher en teck est composé de lattes de bois massif de 19 mm d'épaisseur, 120 cm de longueur et 12 cm de largeur. Les lattes ont une surface lisse et sont préalablement traitées contre les taches et la saleté. La pose est simple et rapide, et s'effectue sur des supports réglables en hauteur, ce qui permet une meilleure adaptation au fond sous-jacent.

Materials



Solid Teak

Pavimenti / Flooring / Planchers

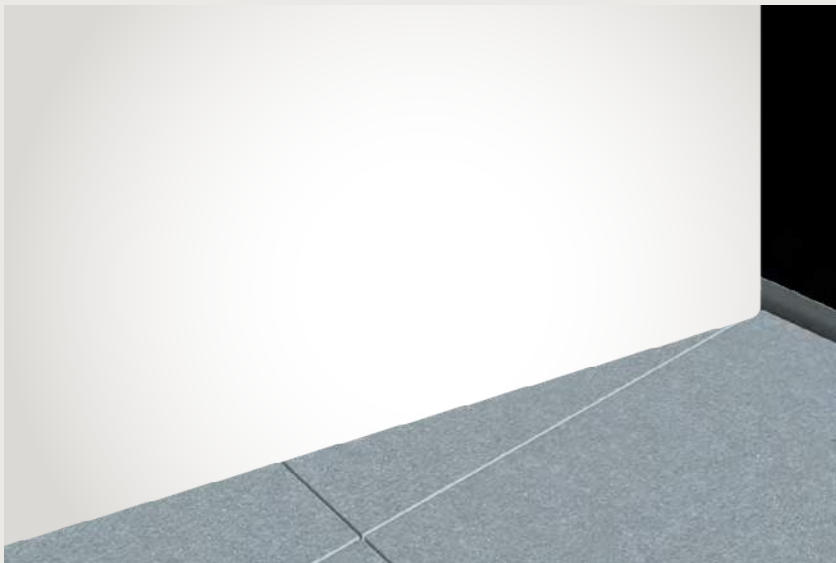

it / La pavimentazione in pietra ceramica è composta da mattonelle di gres con finitura effetto pietra di dimensioni 60 x 60 cm e spessore 10 mm. La posa avviene su supporti regolabili in altezza per consentire il migliore adattamento al fondo sottostante. Le mattonelle di pietra ceramica sono disponibili nei tre colori White, Grey e Black Vulcano.

en / The ceramic stone flooring comprises porcelain tiles with a stone-effect finish, 60 x 60 cm and 10 mm thick. They are simple and quick to lay on supports that can be adjusted in height to give perfect results on the underlying base. These ceramic stone tiles are available in three colours: White, Grey and Black Vulcano.

fr / Le dallage en céramique est composé de carreaux de grès effet pierre mesurant 60 x 60 cm avec une épaisseur de 10 mm. La pose s'effectue sur des supports réglables en hauteur, ce qui permet une meilleure adaptation au fond sous-jacent. Les carreaux de céramique sont disponibles en trois couleurs : White, Grey et Black Vulcano.

Materials



Ceramic
Stone
White



Ceramic
Stone
Grey



Ceramic
Stone Black
Vulcano

Padiglioni senza base

/ Pavilion without base

/ Pavillon sans base

it/ Ogni padiglione Eivissa può essere installato direttamente a terra, se il fondo lo consente, e fissato con opportune staffe. La scelta di un modello senza la base e il pavimento non pregiudica né la selezione dei tipi di coperture, né la possibilità di applicare tutti gli accessori perimetrali come vetrate o tendaggi. In particolare per il montaggio delle vetrate, le guide di scorrimento saranno fissate direttamente al suolo su cui poggiano i pilastri.

en/ Every Eivissa pavilion can be installed directly on the ground, if suitable, using suitable fixing brackets. Models without bases or floors can still be fitted with a selection of roofs, and all the perimeter accessories, such as glass panels or curtains. The floor guides for the glass panels will be fixed directly in the ground where the uprights rest.

fr/ Tous les pavillons Eivissa peuvent être installés directement au sol, si le fond le permet, et être fixés au moyen de supports appropriés. Le choix d'un modèle sans base et sans plancher n'affecte pas le choix des types de couverture, ni la possibilité d'appliquer tous les accessoires latéraux comme les panneaux vitrés ou les rideaux. En particulier pour le montage des panneaux vitrés, les rails de guidage seront fixés directement sur le sol où reposent les piliers.

Materials

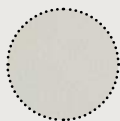

Aluminium
Warm White



Aluminium
Warm Grey



Aluminium
Warm Red



Aluminium
Dark Grey



Aluminium
Coffee
Brown

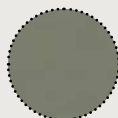

Aluminium
Camouflage
Green



Aluminium
Camouflage
Grey



Aluminium
Pearl
Grey

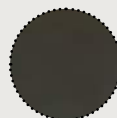

Aluminium
Camouflage
Brown

Dimensioni / Dimensions / Dimensions

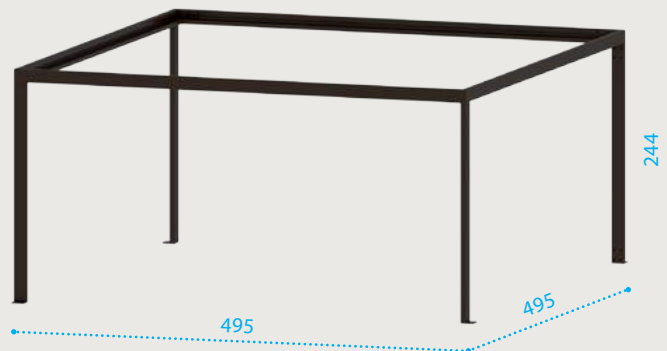
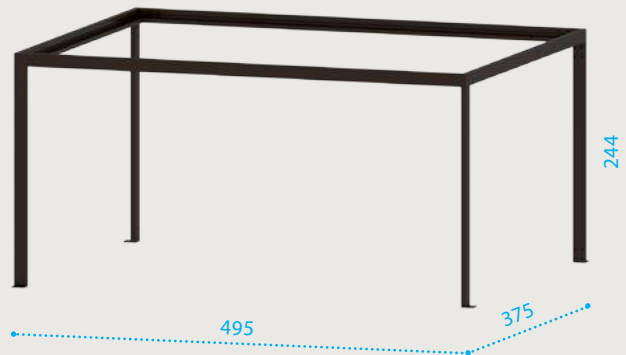
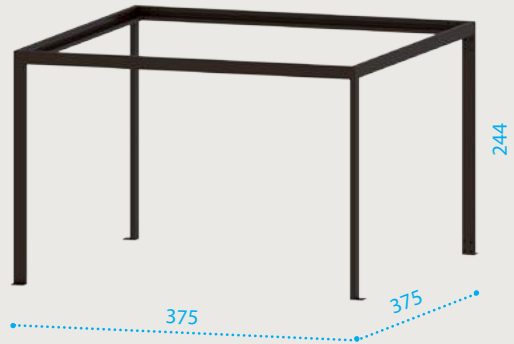



Eivissa . Elementi di
completamento.
Complementary elements.
Éléments complémentaires.

Tenda scorrevole Flow/ Flow sliding canopy / Rideau coulissant Flow



it / Al soffitto di ogni padiglione Eivissa può essere applicata una tenda Flow scorrevole, con funzione ombreggiante e decorativa. La facilità di scorrimento di Flow, la rende estremamente funzionale. I tessuti pesanti e corposi creano un'ombreggiatura fresca e piacevole. È un accessorio compatibile con ogni modello di padiglione e può essere installato anche senza ulteriori coperture protettive (come nel modello Open Air).

en / A sliding canopy can be fitted to the ceiling of any Eivissa pavilion to provide shade and decoration. Flow slides extremely easily, making it highly practical. Heavy, full fabrics create cool, pleasant shade. This accessory is compatible with all Eivissa pavilions and can also be installed without any protective roof (on the Open Air model for example).

fr / Il est possible d'équiper le plafond de tous les pavillons Eivissa d'un rideau coulissant à la fois décoratif et utile pour créer de l'ombre. Flow, grâce à son extrême facilité de coulissement, est extrêmement fonctionnel. Les tissus lourds et épais créent une ombre fraîche et agréable. C'est un accessoire compatible avec n'importe quel modèle de pavillon, qui peut également être installé sans couverture de protection supplémentaire (comme dans le modèle Open Air).

Materials

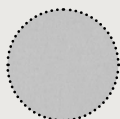
Acrylic
EcrúAcrylic
ArgillaAcrylic
PietraAcrylic Dove
GreyAcrylic
Heirtage
Red

Pannelli vetrati / Glass panels / Panneaux vitrés

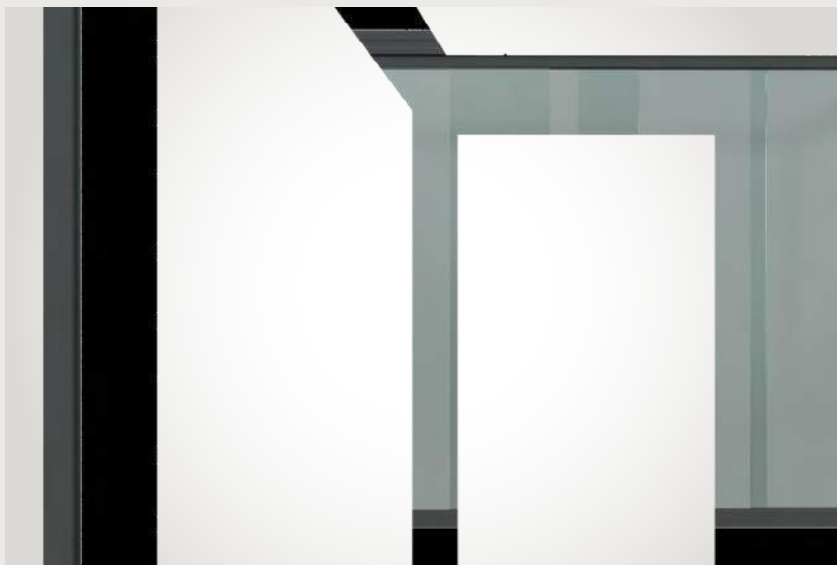

it / Le pareti laterali dei padiglioni Eivissa possono essere chiuse con pannelli in cristallo temperato, creando un ambiente totalmente isolato dall'esterno. L'apertura e la chiusura sono facilitate dalla presenza di una maniglia in alluminio incassata nel pannello, che permette a ciascun elemento di scorrere in modo fluido, sovrapponendosi l'uno sull'altro. Le vetrate scorrevoli possono essere applicate sia sulla struttura con base, che in quella poggiata direttamente a terra. All'interno delle vetrate, possono essere montate le tende in tessuto.

en / The sides of Eivissa pavilions can be closed with tempered glass panels that slide over each other to create a totally isolated space. A steel handle set into each panel makes them easy to open and close. These sliding glass panels can be fixed to both structures with bases and those standing directly on the ground. Fabric curtains can be fitted inside the panels.

fr / Les parois latérales des pavillons Eivissa peuvent être fermés par des panneaux de verre trempés qui se déplacent coulissant l'un sur l'autre, créant un espace totalement isolé de l'extérieur. L'ouverture et la fermeture sont facilitées par la présence d'une poignée en acier encastrée dans le panneau. Les panneaux vitrés coulissants peuvent être posés aussi bien sur la structure avec base que sur celle qui repose directement sur le sol. Des rideaux en tissu peuvent être installés à l'intérieur des panneaux vitrés.

Materials

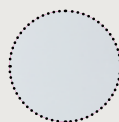

Tempered
Crystal

Tende perimetrali in tessuto / Perimeter curtains in fabric / Rideaux latéraux en tissu



it / Lungo i lati di ogni padiglione Eivissa possono essere applicate delle tende in tessuto leggero che vestono con eleganza la struttura, creando un ambiente accogliente e riservato. La composizione in acrilico delle tende, le rende ultra resistenti agli agenti esterni, mentre la tessitura leggera e trasparente crea un piacevole filtro di luce.

en / Light fabric curtains can be fitted around the sides of all Eivissa pavilions, providing elegant decoration and creating a welcoming, private space. The acrylic composition of the curtains makes them extremely resistant to the elements while their lightweight sheer weave pleasantly filters the light.

fr / Il est possible d'appliquer des rideaux de tissu léger sur les côtés de tous les pavillons Eivissa pour habiller élégamment la structure et créer un espace accueillant et intime. La composition acrylique des rideaux les rend ultra résistants aux agents extérieurs, tandis que la texture légère et transparente crée un filtre de lumière agréable.

Fabrics

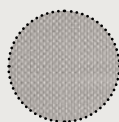

Acrylic Sand

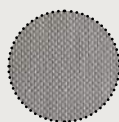

Acrylic Marmot

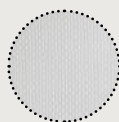

Acrylic Chalk

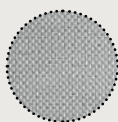

Acrylic Aluminium



Velum White Stone



Velum Grey Stone

Tende perimetrali in corda intrecciata / Perimeter curtains in woven rope / Rideaux latéraux en corde tressée

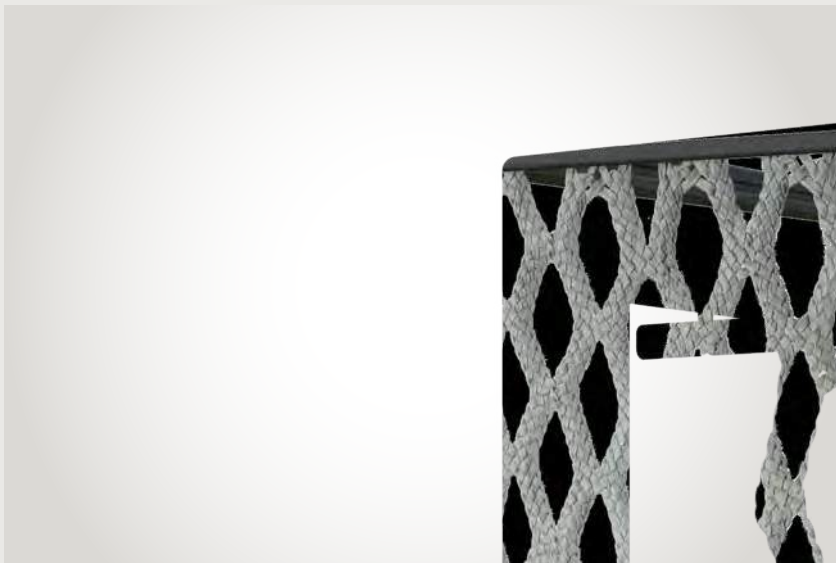

it / Tutte le configurazioni di Eivissa possono essere decorate con pannelli di corda intrecciata artigianalmente, creando suggestivi effetti grafici e giochi di luce e ombra.

en / All the Eivissa configurations can be decorated with artisan-woven rope panels to create wonderful graphics and a chiaroscuro effect.

fr / Toutes les configurations d'Eivissa peuvent être décorées de panneaux de corde tressée artisanalement, qui créent des effets graphiques et des jeux d'ombre et de lumière remarquables.

Materials



Polypropylene
Dove Grey



Polypropylene
Light Grey

Attacchi elettrici / Electrical sockets / Raccordements électriques

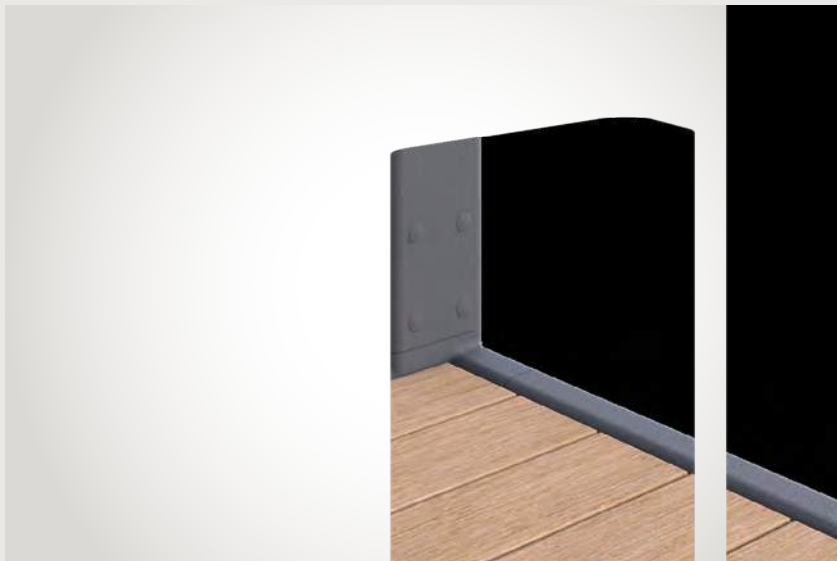

it / All'interno dell'ambiente Eivissa possono essere predisposti degli attacchi elettrici per lampade o altre apparecchiature. Gli elementi in alluminio del colore della struttura inglobano una presa elettrica protetta da un coperchio IP55.

en / Eivissa pavilions can be wired with electrical sockets for lamps or other devices. Sockets are housed in aluminium elements in the same colour as the structure, protected by an IP55 cover.

fr / Dans l'espace Eivissa, il est possible de réaliser des raccordements électriques pour les lampes ou autres appareils. Les éléments en aluminium de la couleur de la structure contiennent une prise électrique protégée par un couvercle IP55.

Materials

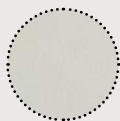

Aluminium Warm White



Aluminium Warm Grey



Aluminium Warm Red



Aluminium Dark Grey



Aluminium Coffee Brown

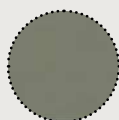

Aluminium Camouflage Green



Aluminium Camouflage Grey



Aluminium Pearl Grey



Aluminium Camouflage Brown





